

⚠ CAUTION - light fitting must be installed by a licensed electrician.

- Please ensure to read instructions correctly for the installation of the fitting provided. Failure to do so will result in a void of warranty and compromises the safety of luminaire.
- Radiant Lighting are not liable for warranties when luminaire is damaged by incorrect installation. The installation of the luminaires must be in accordance with the national safety regulations.
- If the external flexible cable or cord of the luminaire is damaged, it shall be exclusively replaced by the manufacture or his service agent or similar qualified person in order to avoid a hazard.
- When using C-Bus, use universal or trailing edge dimming modules.

Please refer to Radiant Lighting's General Terms & Conditions for more information concerning the installation and warranty of our products.

Installation Instructions

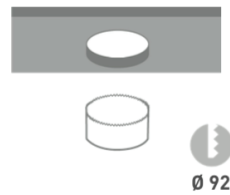
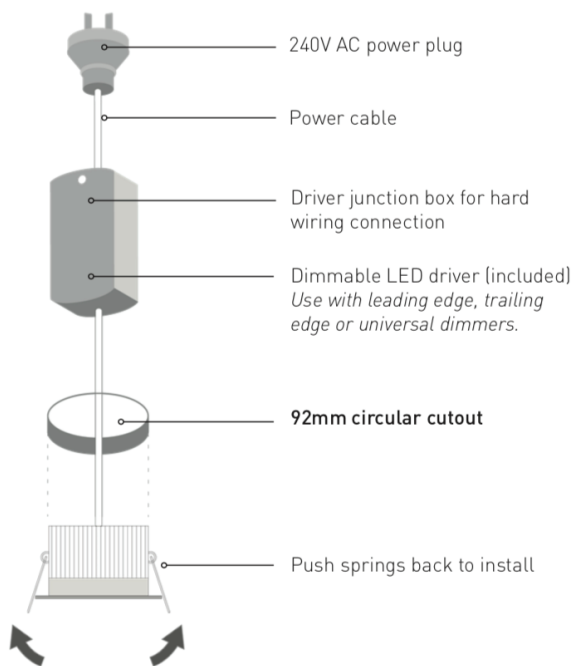

STEP 1
Using a holesaw - create a **92mm circular cutout**.

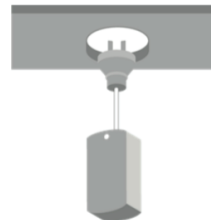

STEP 2
Connect the driver to the mains power socket - located in the ceiling cavity.

Ensure the control gear is placed above any insulation.

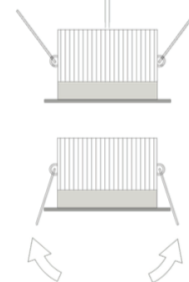

STEP 3
Pull back springs and load unit into ceiling.



Category Recessed Downlight	
Power 12 Watts	
IP Rating 20 (Ceiling Space) 44 (Fascia)	
Material Aluminium	
Warranty 5 Years	

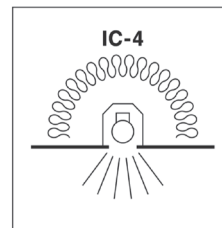

Suitable for residential or commercial use in Australia and New Zealand. Fitting may be abutted and covered according to AS/NZS 60598.2.2:2016, however for optimal efficiency we advise that the luminaire is not covered when installing.

WARNING - RISK OF OVERHEATING OR FIRE IF THE CLEARANCE DISTANCES ARE COMPROMISED. Minimum clearance for luminaire: In accordance with AS/NZS 60598.2.2:2016

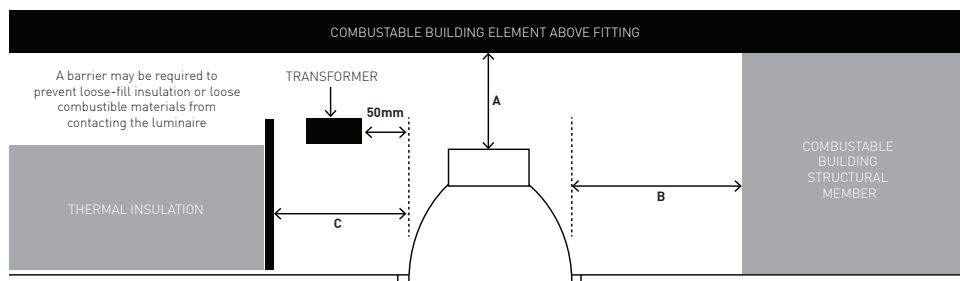

A Height clearance to building element (HCB) = **0mm**

B Side clearance to building element (SCB) = **0mm**

C Side clearance to insulation (SCI) = **0mm**

For warranty information please visit radiantlighting.com.au/warranty