

Company & Collection

Surprisingly clever design lighting...



2018-1

"For mig handler et godt lampedesign om optimal balance mellem form og funktion - og så skal det udstråle kvalitet."

Grundlægger Kjeld Darø

"To me great design is about creating an optimal balance between form and function. It has to radiate quality."

Founder Kjeld Darø



Darø | DNA

Darø | DNA

DK Darøs belysningsdesign har dybe rødder i den danske designarv. Med et gennemtænkt og rent udtryk forener Darø æstetisk enkelthed med funktionalitet og elegant finish. Udgangspunktet for alle designprocesser er enkelthed og kvalitet.

Darø krydrer sin erfaring fra den klassiske designarv med unik innovation, der bringer belysningsdesign ind i den tid, vi lever i samt sikrer, den også har en plads i fremtiden.

Darø-belysning er kendetegnet ved et tidløst og ikonisk formsprog, der giver atmosfære og stemning. Designet udstråler kvalitet, æstetisk ro og en formfaktor med fokus på nøje udvalgte materialer og godt dansk håndværk i alle udviklingsfaser.

For Darø er holdbarhed og lang levetid en essentiel del af et bæredygtigt belysningsdesign. Teknik og funktionalitet er helt integreret og gennemtestet til mindste detalje. Darø kvalitetsdesign ses med øjet og føles med hænderne – det er en fuldbyrdet oplevelse, som ligger i det sanselige.

UK Darø lighting design is deeply rooted in Danish design's heritage. With its functional and pure style, it unites aesthetic simplicity with functionality and elegant finish. The starting point for any design is simplicity and quality.

Darø mixes its experience from the classical designs with unique innovation in a way that brings lighting design into a contemporary lifestyle and ensures it has its place in the future as well.

The hallmark of Darø lighting is its timeless and iconic design language, which creates a unique atmosphere. It radiates quality aesthetic calmness and a form factor focusing on carefully selected materials and Danish craftsmanship in all stages of the development phase.

To us durability and a long life is an essential part of a sustainable design. Techniques and functionality are completely integrated and tested to the last detail. Darø's design quality can be seen by the eye and felt with the hands - it is a consummate experience for the senses.



Grundlagt / founded 1969 Kjeld Darø

Vores designfilosofi

Our design philosophy

DK Grundstenen i Darø's designfilosofi bygger på samspillet mellem årelang erfaring og nye, impulsive kræfter. Som virksomhed udforsker vi nye måder at designe på, og derfor inviteres nytænkning og idérigdom inden for, når designere, der ikke normalt arbejder i belysningsbranchen, udfordres til at tegne stregerne.

Denne frie og uspolerede tilgang til belysning frembringer overraskende og unikke lamper. Uprøvede lampemagere har ingen begrænsninger i designprocessen, men kaster i stedet nye, spændende øjne på idéen om, hvad belysning er. Det udfordrer os til hele tiden at optimere vores kreativitet, så vi samtidig udvikles som brand.

Kombinationen af nutidens designere og vores historie er et samspil, der rykker ved hele opfattelsen af design. Kernen er innovation og nytænkning. For hos Darø ønsker vi ikke blot at skabe godt belysningsdesign – ambitionen er at skubbe til den traditionelle opfattelse for at skabe fremtidens danske klassikere.

Darø-belysning befinder sig i et spænd mellem at være innovativt, funktionelt og udfordrende, men samtidig ikonisk og klassisk.

Designet skal med sin æstetik skabe liv og atmosfære, både når det er tændt og slukket. Hjørnестenen findes i det overraskende element, som er komponeret på en gennemtænkt og velovervejet måde og afsløres i alle de små finesser og detaljer, der træder tydeligt frem, når produktet opleves tæt på og i brug.

UK The foundation of Darø's design philosophy is built on the interaction between years of experience and new, impulsive strengths. We explore new methods and invite creativity into our company in innovative ways, as we challenge designers, who do not usually work in the lighting industry, to create Darø designs. These designers' free and unspoiled approach to lighting creates surprising and unique lamps. The untested lighting creators of our time see no limitations in the design process, but instead they make us see the whole idea of lighting from a fresh perspective. This challenges us to continuously optimize our creativity, while we develop as a brand.

The combination of contemporary designers and our brand history make a great match, disrupting the entire perception of lighting design. Innovation is our beating heart. At Darø our ambition is to disrupt traditional ways of thinking, not just create brilliant design, but create contemporary and future classics.

Darø lighting exists as a balance between innovation, functionality and challenging solutions that can become iconic and classic. With their aesthetics, our designs are meant to create life and atmosphere regardless of whether they are switched on or off. The cornerstone of our design philosophy finds itself in the surprising element, composed in a carefully conceived way and revealed in every little refinement and detail, which stand out clearly when the product is experienced up close and while in use.



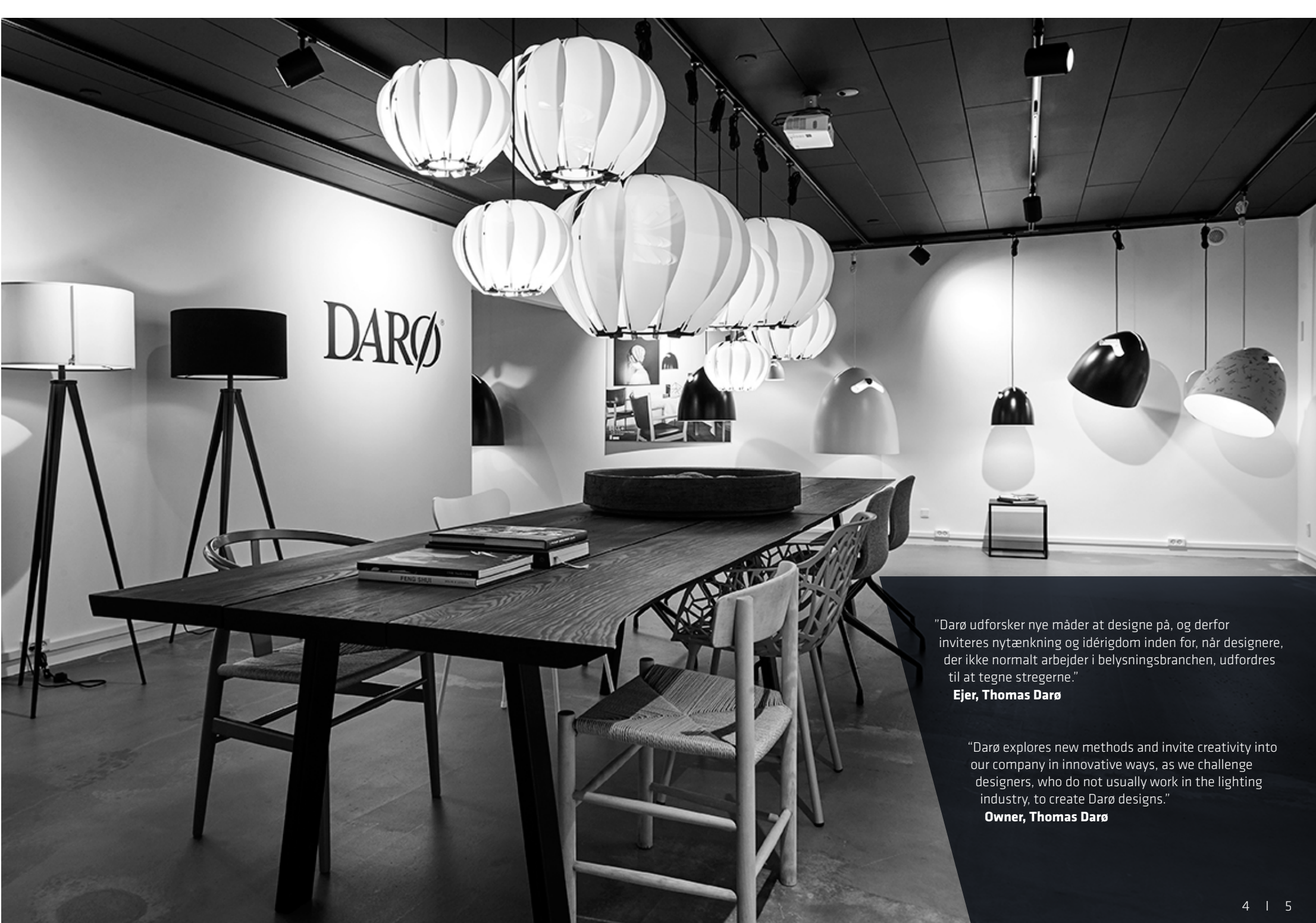

DARØ

"Darø udforsker nye måder at designe på, og derfor inviteres nytænkning og idérigdom inden for, når designere, der ikke normalt arbejder i belysningsbranchen, udfordres til at tegne stregerne."

Ejer, Thomas Darø

"Darø explores new methods and invite creativity into our company in innovative ways, as we challenge designers, who do not usually work in the lighting industry, to create Darø designs."

Owner, Thomas Darø

Designerne

The designers



Kjeld Darø

Grundlægger / Founder + product designer



Thomas Darø

Ejer / Owner + product designer



Thomas Holst Madsen

Product designer MDD



Hans Christian Asmussen

Product designer MD



Says Who

Product designers

Lamperne

The lamps



Trion



Arkiturbine



Bell+



Paso Tri



Paso Wood



Archos



Costa



Fiara

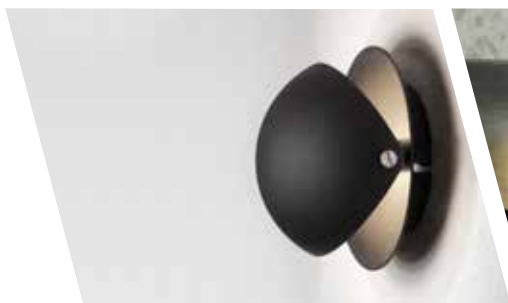

Gisario



Architect

"Darø producerer ikke metervarer, men udfordrer ideen om klassisk stilen designbelysning – kvaliteten går vi ikke på kompromis med. Vi er tidssvarende og udfordrende, også når det gælder teknologi og funktionelle løsninger."

Ejer, Thomas Darø

"At Darø we do not make standard products, but challenge the idea of classic stylish design lighting – we do not compromise on quality. We are contemporary and challenging, also when it comes to technology and functional solutions."

Owner, Thomas Darø

Passionen bag

The passion behind

DK Bag Darø står ejer Thomas Darø, som er drevet af en dyb passion for design, nytænkning og udvikling. Thomas er kreatøren og håndværkeren med bredt kendskab til materialer inden for lamper og belysning. Han er tovholderen in house og står for produktionen samt den daglige ledelse. Han designer selv og udfordrer Darø's eksterne designere til at bidrage med nye tanker og designs, der matcher Darø's værdigrundlag og passer ind i kollektionen. De eksterne Darø designere er et vigtigt element for udviklingen af nye innovative produkter.

Fælles for folkene i Darø er ønsket om at puste nyt liv i belysningsbranchen. Vi udvikler designs, der skaber værdi og gør en forskel, og som mennesker kan identificere sig med. Kvalitet er en af hovednerverne i Darø, og hvert design er unikt. I Darø har vi skabt plads til rum og nytænkning – et sted, hvor kreativiteten kan få frit spil. Det smitter af og stiller krav til udvikling af anderledes, originale metoder til at skabe liv gennem belysning.

UK Owner Thomas Darø is the beating heart of Darø driven by a deep passion for design, innovation and originality. As the creator and craftsman, Thomas has a broad knowledge of materials within lamps and lighting. He is the in-house project manager and in charge of production and management on a daily basis. He is a designer himself and challenges the external designers to contribute with their innovative thoughts to match the Darø values and collection.

At Darø our overall attitude to creativity and our quest to revitalize the lighting industry are things we have in common. We develop value-adding designs that make a difference, designs that people can relate to. Quality is key at Darø, and every design is unique. At Darø we make room for innovation – a place to let creativity loose. It infects the whole company and demands development of alternative, original methods to create life through lighting.



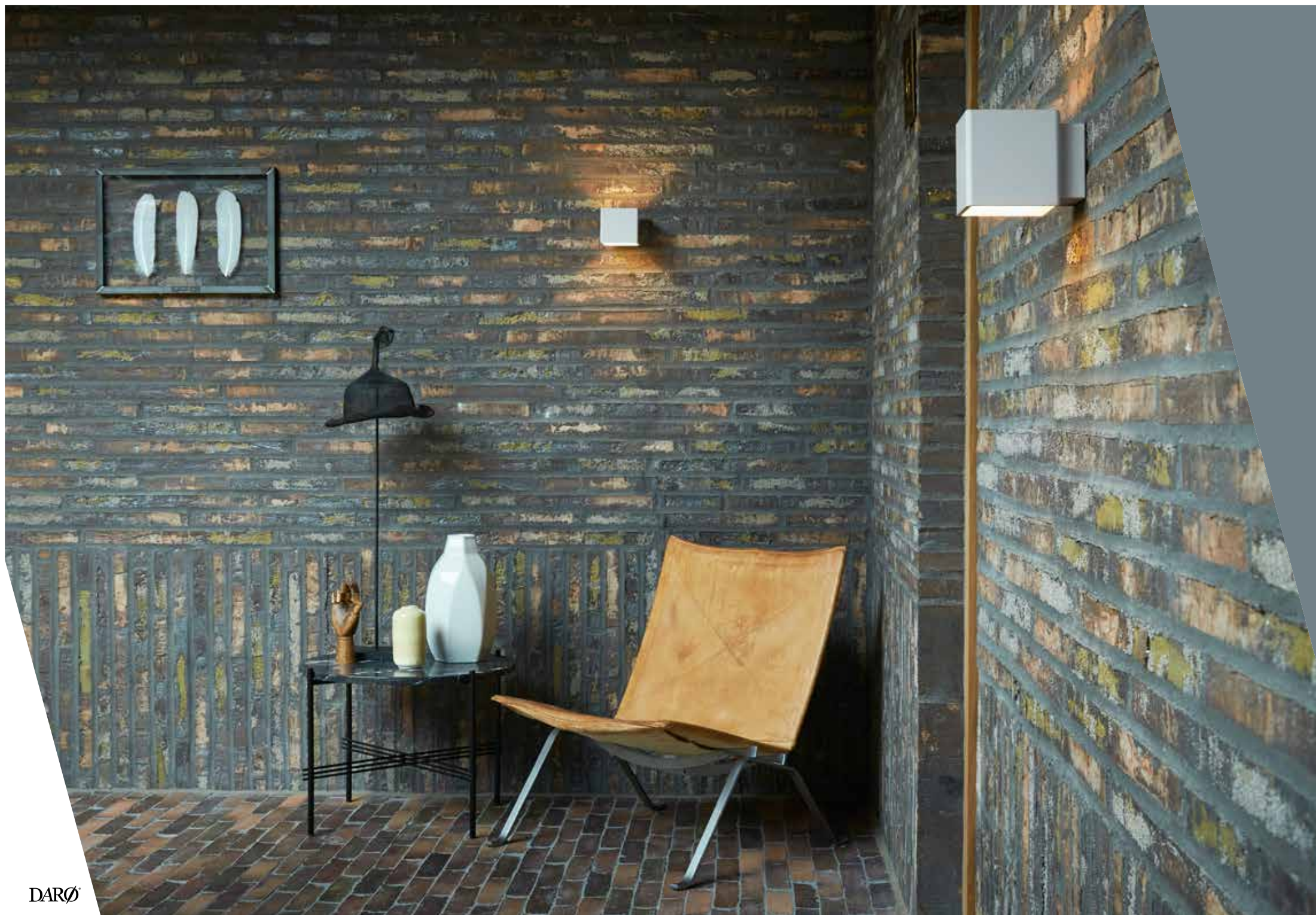

Kollektionen

The collection



DK Originale og nutidige designs definerer vores kollektion, og vi bestræber os på at holde os foran de foranderlige tider og trends. Vi ser vores lamper som indretningslementer i deres egen ret. Darø design lamper er dansk design, når det er bedst. Lad os vise dig lyset.

UK Original and contemporary designs define our collection and we aim at staying ahead of changing times and trends. We see our lamps as design elements in their own right. Darø design is Danish design at its very best. Let's show you the light.

Trion

/ design by Thomas Darø





DK Den smukke og velkendte trompetlampe får nyt lys. Med en retrofit LED løsning, der er helt integreret i lampens smukke form, så selve lyskilden ikke er synlig, tager Trion skridtet ind i fremtiden. Vælg selv styrke og farvetone og få samtidig LED fordele med lang levetid og reduceret strømforbrug.

Kollektionen, der byder på en mat sort og en mat hvid aluminiumsskærm, udvides nu med to lækre tidløse pasteller; Storm Grey og Dark Sand. Den velkendte aluminiumstop ændres til en massiv messingstop med diskret indgraveret Darø logo, som både en understregning af det klassiske design og nutidens leg med farver og materialer. En pendel lampe, der passer ind alle steder i indretningen.

UK The beautiful and characteristic trumpet-shaped pendant is seeing new light. Introducing a retrofit LED solution, which is completely integrated into the beautiful shape of the lamp, so the light source itself is not visible, Trion moves towards the future. Choose your preferred light intensity and colour, and get the advantages of LED with long life and reduced power consumption.

The collection, which offers a matt black and white aluminium shade, is now extended with two incredibly beautiful and timeless pastel colours: Storm Grey and Dark Sand. The well-known aluminium top is changed to a massive brass top with the Darø logo discretely engraved. It is a perfect combination of the classic design and contemporary experiments with colour and materials. A pendant that fits anywhere and any one.

Arkiturbine

/ design by Hans Christian Asmussen





DK Arkiturbine fremkalder en unik stemning i ethvert rum. Det udsendte lys fremhæver rammens designelementer ved at skabe en legende skyggeeffekt, der giver rummet en stemningsfuld atmosfære. Inspirationen til Arkiturbine kommer fra en fundamental fascination af æstetikken og dynamikken i konstruktion og asymmetri. Designer Hans Christian Asmussen har brugt en turbines asymmetri som omdrejningspunkt. Konstruktionen er enkel og let at forstå, men resultatet er overraskende i sit udseende.

Aluminiumsrammen samles uden brug af skruer, bolte eller svejsninger, og konstruktionen holdes ubesværet sammen af det funktionelle design. De laserskårne blade er lavet af UV-beständig, industriel kvalitetsvinyl, som giver et dejligt varmt og dæmpet lys.

UK Arkiturbine provides a pleasantly warm and subtle light. The light accentuates the design elements of the frame by creating a playful shadow effect adding to the atmosphere of the room. The inspiration for Arkiturbine comes from a fundamental fascination of aesthetics and the dynamics and asymmetry in the construction. Designer Hans Christian Asmussen has used the asymmetry of a turbine as inspiration throughout the design process. The construction is simple and easy to understand and surprising in its finish.

The aluminium frame is assembled without any screws, bolts or welding and is kept together by the meticulous design. The laser cut leaves are made by high-quality UV resistant industrial vinyl and provide a pleasant, warm subtle light.





DK Arkiturbine er vinder af London Design Awards 2015 i kategorien Produkt Design for sine kreative og innovative løsninger i udviklingen og produktionen af designet. Der er blevet lagt vægt på holdbarhed i materialevalget og bæredygtighed i produktionen. Det er vigtigt at tage hånd om miljøet, når man skaber design, der skal holde i mange år, og det har Arkiturbine nu modtaget anerkendelse for.

UK Arkiturbine is winner of London Design Awards 2015 in the Product Design category for its creative and innovative solutions in the development and production of the design. Emphasis has been put on the sustainability of materials and production. Today, it is important to take care of the environment when you create designs to last for many years, and Arkiturbine has been acknowledged for doing just that.



Bell+

/ design by Thomas Holst Madsen





DK Inspirationen til Bell+ udspringer af ønsket om at udfordre opfattelsen af loftslampen som noget statisk. Thomas Holst Madsen har brugt simple elementer til at skabe en overraskende klog funktion. En perfekt afbalanceret skærm hviler på en smuk egetræstav. Skærmen kan vippe i to retninger og rotere 360 grader, hvilket giver en fleksibel retning af lyset.

Fordelingen af lys er afgørende for design og lyseffekter, som skabes gennem siderne og toppen. De forskellige størrelser og alsidigheden ved Bell+ giver en lang række anvendelsesmuligheder, der vil komplimentere ethvert bord og tjene som godt læselys.

UK The conceptual idea behind Bell+ was to challenge the perception of a pendant as something static. Thomas Holst Madsen has used simple elements to create a surprisingly clever function. A perfectly balanced shade rests on a beautiful oak bar. The shade can be tilted in two directions and rotate 360 degrees, which provides you with a flexible direction of light.

The light dispersion is crucial for the design and light effects created through the sides and the top. The various sizes and the versatility of Bell+ provide a long range of applications, and will compliment any table and serve as a good reading light.

AWARD 2014
DESIGN PLUS
powered by: light+building



German
Design Award
SPECIAL
MENTION 2015

Paso Tri

/ design by Thomas Darø



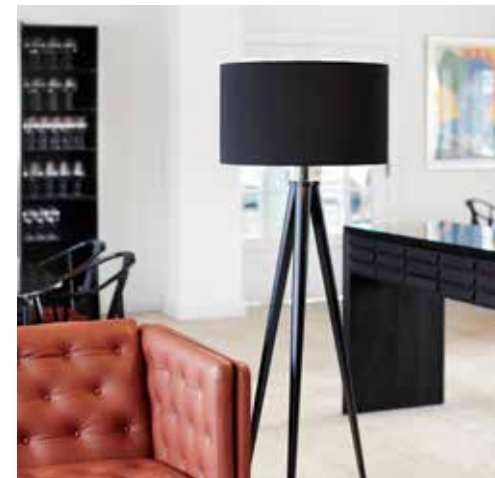

DK Inspirationen til Paso Tri kommer fra det ikoniske trekløver, der dukker op på græsmarken om foråret. Thomas Darø har fortolket trekløverbladets fine form og videreført det til Paso Tri. På toppen af gulv- og bordlampen findes tydelige former af trekløverblade, der strækker sig fint ud i lampens ben. Kablet løber diskret inde i et af benene, hvilket understøtter det fine design og giver et rent og let indtryk.

Tre eller 'tri' er den dominerende faktor i Paso Tri, da lampen er tilgængeligt både som pendel, bord- og gulvlampe. Benene er lavet af stål i en smuk sort finish, og lampeskærmen fås i tre forskellige grundfarver – sort, grå og hvid. Skærmen er behændigt fastgjort ved hjælp af velcro, som gør det nemt at ændre farven ved blot at ændre tekstilet. Desuden åbner det op for en verden af muligheder for at tilpasse Paso Tri til alle typer indretninger.

UK The Paso Tri design is inspired by the iconic three clover you see on fields in the spring. Thomas Darø has interpreted the shape of the three clover and applied it in Paso Tri. On the top of the floor- and table lamp you see the distinctive three clover shape stretching out into the steel base of the lamp. The cable is discretely taken through one of the legs, and supports the clean and light design.

Three or 'Tri' is the dominating factor in Paso Tri as the lamp is available both as pendant, a table lamp and a floor lamp. The legs are made of steel in a beautiful black finish, and the shade is available in three different colours: Black, grey and white. The shade is conveniently secured with velcro, which makes it easy to change the colour of the shade just by changing the textile. This opens up for adapting the Paso Tri to any interior décor.



PASO Universe



Paso Universe
A world of possibilities
online at www.daroe.dk



Paso Wood

/ design by Says Who





DK Paso Wood er en ny belysningsserie, der tager naturen med helt ind i boligen. Samspillet og kontrasten mellem det varme træ og det kolde stål skaber spændende dybder, så designet fremstår velafbalanceret med et harmonisk og tidløst udtryk.

Det geometriske formsprog, inspireret af cirklen, har en lethed over sig og en ren symmetri, noget de fleste kan forholde sig til. Der er balance mellem top og bund og en flot finish i mødet mellem stål og træ. Træ er indbegrebet af liv og kvalitet, og Paso Wood udfordrer den originale line med ståldetaljer og runde skærme i de mere bløde liner i træstellet.

UK Paso Wood is a new lighting series taking nature all the way to the living room. The combination and contrast that exist between the warm wood and the cold steel create new exiting depths, so the design becomes well-balanced with a harmonious and timeless expression.

The geometric shape inspired by the circle has a lightness and symmetry, which most people can relate to. There is a balance between top and bottom and an excellent finish in the meeting of wood and steel. Wood is the essence of life and quality and Paso Wood challenges the original Paso-line with the softer lines in the wooden base.

Archos

/ design by Thomas Darø



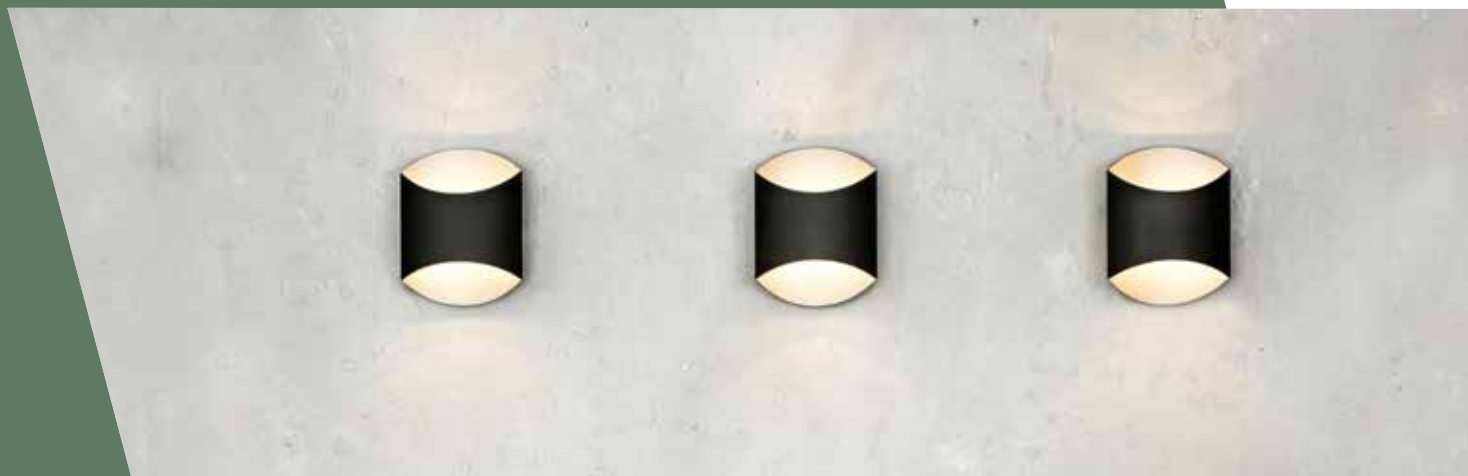

DK Væglampen Archos er med sin bløde kurve inspireret af vinden, som fylder sejlet på en sejlbåd. Thomas Darø har gentaget formen for at skabe et let og indbydende look. Den ekstruderede og skårne aluminiumsskærm afslører de bløde kurver fra alle vinkler. Den udvendige matte finish står som fin kontrast til det reflekterende sølv på indersiden af skærmen – som solen reflekteres i havet.

Væglampen er både elegant, holdbar og let at montere. Den fleksible monteringsplade tillader, at kablet kan løbe lige ind i væggen eller på væggen. Archos passer perfekt ved siden af et fladskærms-TV, ved siden af sofaen eller sengen – eller som en raffineret væglampe i gangen.

UK With its soft curves, the wall lamp Archos expresses a movement inspired by the wind filling up the sails on a sail boat. Thomas Darø has repeated the shape in his design to create a light and inviting look. The extruded cut out aluminium screen reveals the soft curves from all angles. The outside matt finish is a fine contrast to the reflective silver surface on the inside of the shade – in the same way the sun is reflected in the ocean.

The wall lamp is both elegant, durable and easy to mount. The flexible mounting plate allows the cabling to go directly into the wall or on the wall. Archos suits a flatscreen TV perfectly, next to the sofa or the bed, or as a refined wall lamp in the hall.

Costa
/ design by Thomas Darø





DK Inspirationen til Costa stammer fra ønsket om at skabe effektfuld belysning gennem enkle former. Designeren har leget med geometriske former for at skabe en god balance mellem lampe og funktionalitet. Det kubistiske design skaber et firkantet center, som udstråler og projekterer et trekantformet lys på væggen i toppen og bunden eller på begge sider, afhængigt af hvordan den er monteret.

Den fem millimetertykke aluminiumslampeskærm giver et robust og holdbart udtryk og fås i en mat sort eller mat hvid finish. Den reflekterende sølvfinish på skærmens inderside skaber en fantastisk og overraskende effekt. Costa vil klæde enhver væg eller gang.

UK The inspiration for Costa comes from a wish to create a powerful lighting source through simple shapes. The designer has played with geometric shapes to create a good balance between lamp and functionality. The cubistic design creates a square centre radiating and projecting a triangular light on the wall in the top or bottom or on both sides, depending on how it is mounted.

The five-millimeter-thick aluminium shade provides a robust and durable expression and is available in a matt black or matt white finish. The reflecting silver finish on the inside of the shade creates a remarkable and surprising effect. Costa will suit any wall or hall way.

Fiora

/ design by Thomas Darø



DK Inspirationskilden til Fiara findes i kontrasten mellem kubiske og runde former. Designeren har kombineret disse former for at skabe en væglampe, der både er tydeligt skitseret og samtidig illustrerer bløde, afrundede linjer, som giver Fiara et beskedent, moderne look. Når man ser nærmere på den robuste aluminiumsskærm, udstråler den både holdbarhed og kvalitet. Skærmen fås i en mat sort eller mat hvid farve, mens indersiden er malet med reflekterende sølv, som skaber en elegant effekt.

Fiara skinner op og ned ad væggen i en halvcirkel, hvilket giver et godt direkte og indirekte lys. Fiara komplimenterer enhver gang eller trappe og er en stor lyskilde for alle vægområder - f.eks. ved siden af en seng, sofa eller andet, du ønsker at fremhæve.

UK The inspiration for Fiara is found in the contrast between cubistic and round shapes. The designer has combined these forms to create a wall lamp, which is both clearly sketched and yet illustrates soft rounded lines, giving Fiara a modest modern look. When you take a closer look at the robust aluminium shade, it radiates robustness and quality. The shade is available in a matt black or matt white colour with an inside reflective silver cover giving an elegant effect.

Fiara shines up or down the wall in a semi-circle providing a good direct and indirect light. Fiara complements any hallway or staircase and is a large light source for any wall - e.g. next to the bed, couch or other areas you wish to emphasize.

Gisario

/ design by Kjeld Darø





DK Gisario udfordrer opfattelsen af væglampen som en statisk kilde til lys. Designeren har – inspireret af øjenlåget – skabt en lampe med en bevægelig skærm, som kan vippes op eller ned for at justere lyset og samtidig fjerne genskin fra lyskilden. Dens bløde form reflekterer lyset og skaber dekorative, kunstneriske effekter på væggen.

Lampen er lavet af stål og fås i en mat hvid, mat sort eller satinfinish. Ligesom alle Darøs væglamper er Gisario meget alsidig i installationen og tillader ekstern og intern kabling direkte ind i væggen. Gisario er ideel som belysning til gange, trapper, stuer, spisestuer, eller endda som dekorativ belysning i balsale mv.

UK Gisario challenges the perception that a wall lamp is a static light source. The designer is inspired by the movement of the eyelid in his lamp, which has a movable shade that can be tilted up or down to adjust the light and remove light from the light source. The soft shape reflects the light and creates decorative artistic effects on the wall.

The lamp is made of steel and is available in a matt white, matt black or satin finish. As all Darø wall lamps, Gisario is very versatile in installation and allows both external and internal cabling directly into the wall. Gisario is ideal as lighting for the hallway, stair cases, living rooms, dining rooms or even as a decorative light source in ball rooms.

Architect

/ design by Thomas Darø





DK Ambitionen med Architect er at give den klassiske arkitektlampes genkendelige træk et moderne twist. I processen har designeren fokuseret på at sikre en høj grad af fleksibilitet og funktionalitet, samtidig med at nogle af de tekniske designelementer understreges.

De kantede former og det futuristiske design, blødgjort af en let børstet satinaluminium-finis, er nogle af Architects tydelige træk. Ved nærmere eftersyn afsløres det interne wiresystem, som elegant forener styrke og raffinement. Med to fleksible led er det muligt at indstille Architect i forskellige positioner fra den yderste stilling til en næsten helt foldet stilling. Architect fås både som en bordlampe fastgjort på en solid base, eller en velmonteret version på væggen med et elegant beslag.

UK The ambition with Architect is to provide the classic architect lamp's recognizable features with a modern twist. In the process, the designer has focused on securing a high degree of flexibility and functionality, while underlining some of the more technical design elements.

The edgy shapes and futuristic design features have been softened by a light brushed satin-aluminium finish, which provides Architect with quite distinguishable features. When you take a closer look, you will see the internal wiring system, which elegantly unites strength and refinement. With two flexible joints, it is possible to position Architect in different positions from the completely extended to an almost completely folded position. Architect is available as a table lamp fastened on a solid base or as a wall mounted version fastened with an elegant wall bracket.

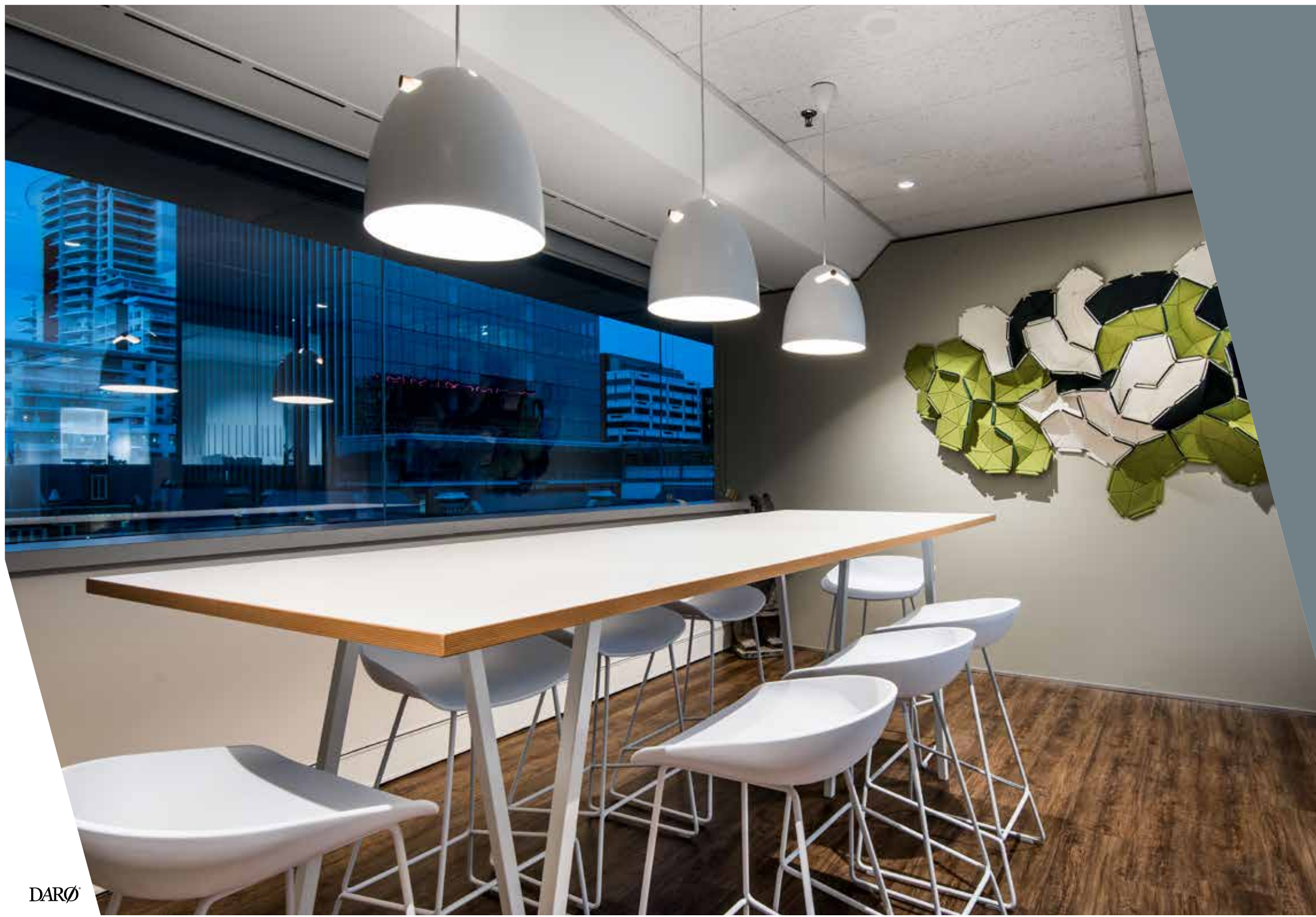

Referencer

References



DK Darø's forskellige produkter er repræsenteret i en lang række sammenhænge. Her præsenteres en række eksempler på, hvordan vores lamper er tænkt ind som centrale elementer i forskellige indretningsløsninger.

UK Darø lamps are represented in a large number of contexts. Here you will see examples of how our lamps become central elements in various interiors.

Projekter

/ Projects



Clarion Hotel & Congress Malmö Live

/ Hotel in Malmö - Sweden





DK Darø har leveret designlamper til indretningen af over 400 værelser i det topmoderne hotel og kongrescenter i Malmö: Malmö Live tilbyder alt, man kan ønske sig som turist og kongresgæst. Der er ikke sparet på detaljerne, og alle værelser er indrettet med møbler fra Skandinaviens førende designere. Darø's Paso-serie passer perfekt ind i konceptet, og i forbindelse med dette projekt har Darø specialdesignet tekstilerne med guldstof indvendigt i skærmen. Det er blevet et rigtig flot resultat.

UK Darø has delivered design lamps for the interior of more than 400 rooms in the top modern hotel and conference centre in Malmö: Malmö Live offers anything you could wish for as a tourist or conference guest. A true attention to detail and all rooms decorated with furniture from the leading designers of Scandinavia. Darø's Paso-series is perfectly suited for this concept, and in connection with the project, Darø custom-designed the textiles with golden fabric on the inside of the shade. We are very happy with the result.

Laplands Universitet

/ University of Lapland





DK Laplin Yliopisto. Laplands Universitet har gennem den seneste tid foretaget en gennemgribende renovering af de eksisterende bygninger og rum, der skaber de daglige rammer for kunst- og designstuderende på Universitetet. Indretningsarkitekterne Suvi-Maria Silvola og Laura Seppänen har haft fokus på funktionalitet og nordisk design, og den kreative duo har valgt at bruge Darø's Bell+, som til fulde opfylder disse kriterier.

UK Laplin Yliopisto. Lapland University has recently gone through an extensive renovation of the existing buildings and rooms that set the daily scenery for the Arts and Design students at the University. The interior decorators Suvi-Maria Silvola og Laura Seppänen have had their focus on functionality and Nordic design, and the creative duo has chosen to use Darø's Bell+, which fulfills these criteria perfectly.

Houlberg og Wittrup a/s - Bilhus

/ Houlberg & Wittrup a/s - car dealership

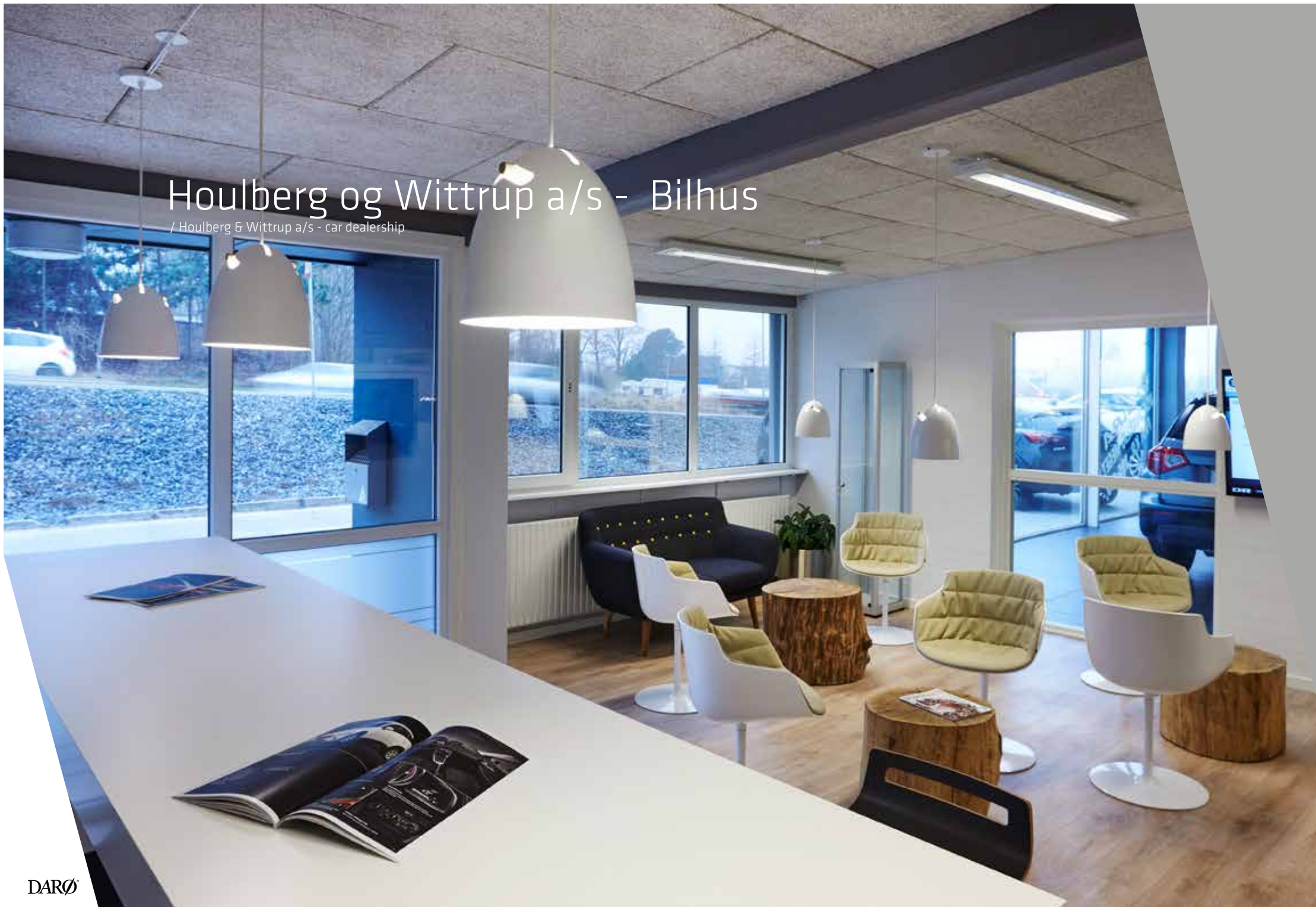



DK Ved en gennemgående renovering af Bilhuset Houlberg og Wittrup a/s i Randers, er kundernes venterum blevet indrettet i en elegant moderne nordisk stil, og til belysningen er valgt Darø Bell+ 20 i en elegant mat hvid version. Bell+ matcher perfekt indretningsstilen, der er et mix af rustikke træstubbe fra Rold Skov og BB Italia stole og kundens egen sofa. Det er indretningsarkitekter JENSENplus, der har stået for valg af møbler og indretning.

UK The car dealership Houlberg & Wittrup a/s in Randers has recently renovated its premises. The customer room has been decorated in an elegant, modern Nordic style, and for the lighting design Darø Bell+ 20 lamps in a discrete matt white version was chosen. Bell+ is a perfect match to the décor - a mix of rustic tree stump furniture from Rold forrest in Denmark, chairs from BB Italia and the customer's own couch. It is interior designers JENSENplus, who have been in charge of the selection of furniture and the décor.

Hudplejeinstituttet Randers

/ Wellness Clinic in Randers - Denmark





DK Hudplejeinstituttet Randers

Hudplejeinstituttet er en klinik i Randers midtby, der tilbyder mange former for skønhedsbehandlinger, wellness og yogahold. Klinikken er blevet flot indrettet med Darø's sorte Fiora på væggene. Fiora skaber en flot lyseffekt og er med til at sætte rammerne for afslapning og velvære.

Arkitekt: BRUNOJAKOBSENDESIGN+

UK Wellness Clinic, Randers

Hudplejeinstituttet is a clinic in the centre of Randers that offers many kinds of beauty treatments, wellness and yoga classes. The clinic has been beautifully decorated with Darø's black Fiora on the walls. Fiora creates a great effect and helps set the mood for relaxation and wellness.

Architect: BRUNOJAKOBSENDESIGN+

Bar - Door 49 | Perth - Australien

/ Bar - Door 49 | Perth - Australia

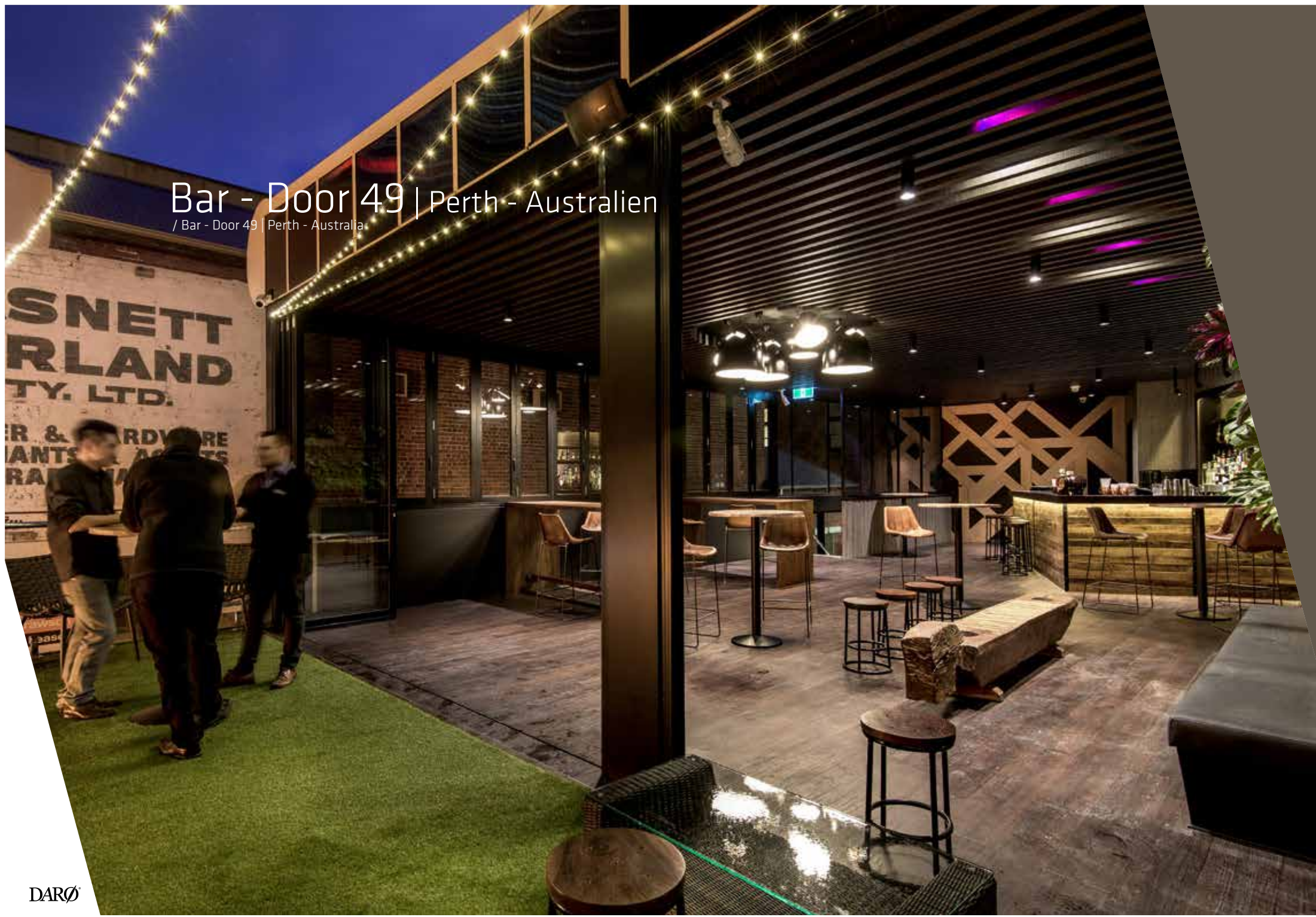



DK Door 49 King Street, Perth

Bell+ er brugt i indretningen af den hippe og populære bar Door 49 på King Street i midten af Perth, Australien. Bell+ er en central del af loftsudsmykningen med en stor klase af Bell+, der nærmest bryder igennem loftet. Door 49 er en roof-top bar, hvor der serveres forfriskende cocktails og lækker mad i en fantastisk atmosfære. Indretningen er udført af BHO Interiors i samarbejde med Darø's australske distributør Radiant Lighting.

UK Door 49 King Street, Perth

Bell+ has been used in the decoration of the hip and popular bar Door 49 on King Street in the middle of Perth, Australia. Bell+ is a central part of the ceiling decoration with a large cluster of Bell+ almost breaking through the ceiling. Door 49 is a roof-top bar that serves refreshing cocktails and delicious food in an amazing atmosphere. The interior decoration was done by BHO Interiors in cooperation with Darø's Australian distributor Radiant Lighting.

2018-1



Architect

/ design by Thomas Darø

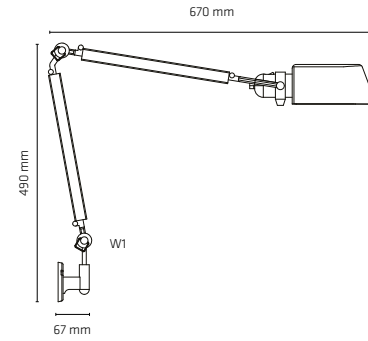
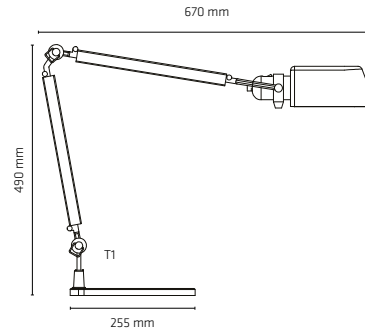

Product	Type	Colour	Item no.	EAN number	Watt-Socket-Voltage	Light source
Architect T1	table lamp	Aluminium	R119B17	57 09349 022616	60W - E27 - 240V	Excl.
Architect W1	wall lamp	Aluminium	R119V17	57 09349 022623	60W - E27 - 240V	Excl.

Shipping information	Net. Weight KGS (product)	Gross weight KGS (incl. Packaging)	Box dimension cm	CBM	PCS./Master	Installation	Material
Architect T1	3,780	4,412	28 x 13 x 70	0,033	1	IP20, class II, 2m transparent cable, switch on head	Aluminium
Architect W1	0,780	1,324	23 x 13 x 70	0,027	1	IP20, class II, 2m transparent cable, switch on head	Aluminium

2018-1

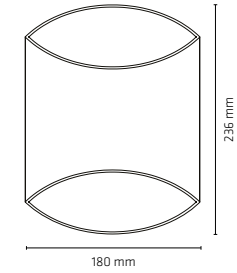
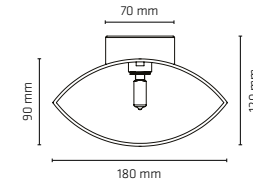
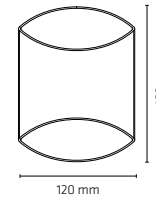
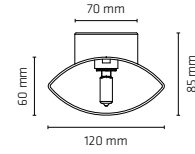

Archos

/ design by Thomas Darø

Product	Type	Colour	Item no.	EAN number	Watt-Socket-Voltage	Light source
Archos 12 W1	wall lamp	Matt white	R10V1122	57 09349 024429	33W - G9 - 240V	Excl.
Archos 12 W1	wall lamp	Matt black	R10V1123	57 09349 024436	33W - G9 - 240V	Excl.
Archos 18 W1	wall lamp	Matt white	R10V1182	57 09349 024702	33W - G9 - 240V	Excl.
Archos 18 W1	wall lamp	Matt black	R10V1183	57 09349 024719	33W - G9 - 240V	Excl.

Shipping information	Net. Weight KGS	Gross weight KGS	Box dimension cm	CBM	PCS./Master	Installation	Material
Product	(product)	(incl. Packaging)					
Archos 12 W1	0,400	0,626	16 x 13 x 21	0,006	1/3/12	IP20, class II, 2m transparent cable, with in-line switch and euro-plug	Aluminium shade / steel backplate
Archos 18 W1	0,780	1,128	21 x 15 x 28	0,011	1/3/12	IP20, class II, 2m transparent cable, with in-line switch and euro-plug	Aluminium shade / steel backplate

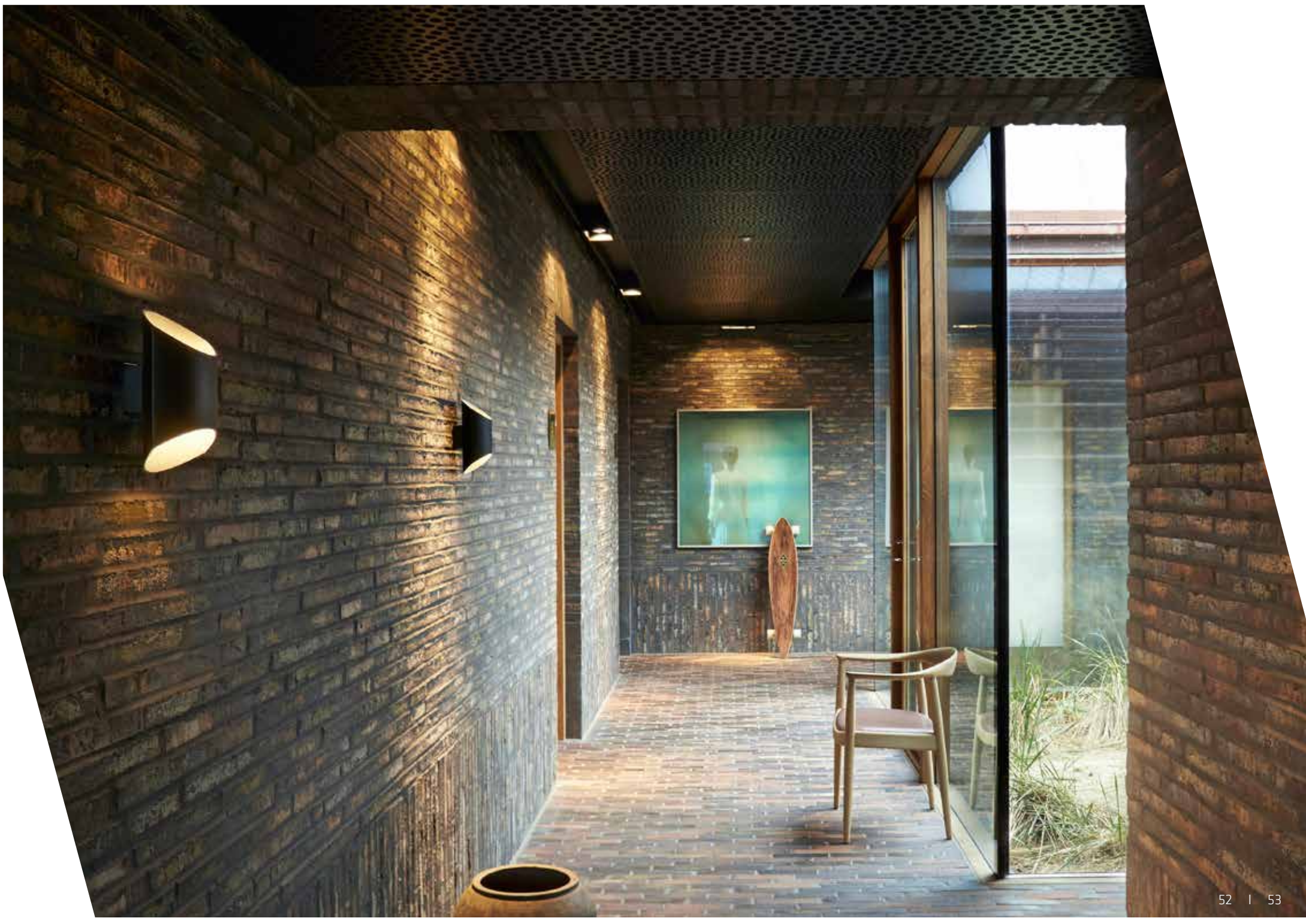

2018-1



Arkiturbine

/ design by Hans Christian Asmussen

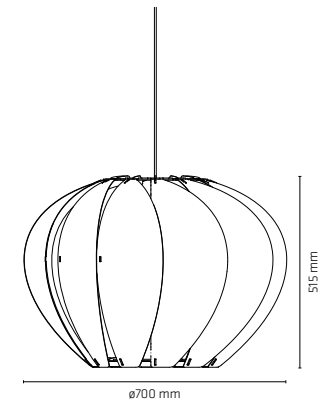
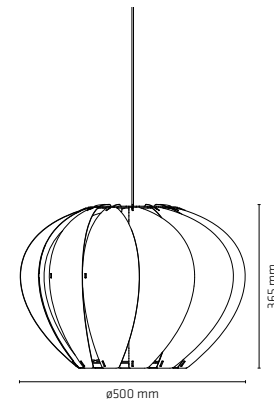
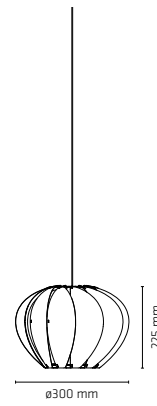

Product	Type	Colour	Item no.	EAN number	Watt-Socket-Voltage	Light source
Arkiturbine 30 P1	pendant	White-black	D18P13023	57 09349 025006	40W - E27 - 240V	Excl.
Arkiturbine 50 P1	pendant	White-black	D18P15023	57 09349 025013	60W - E27 - 240V	Excl.
Arkiturbine 70 P1	pendant	White-black	D18P17023	57 09349 025020	60W - E27 - 240V	Excl.

Shipping information	Net. Weight KGS	Gross weight KGS					
Product	(product)	(incl. Packaging)	Box dimension cm	CBM	PCS./Master	Installation	Material
Arkiturbine 30 P1	0,980	1,560	33 x 33 x 30	0,042	1	IP20, class II, 3m black textile cable, incl. canopy	Aluminium frame, plastic blades
Arkiturbine 50 P1	1,980	4,020	53 x 53 x 45	0,164	1	IP20, class II, 3m black textile cable, incl. canopy	Aluminium frame, plastic blades
Arkiturbine 70 P1	4,100	7,960	75 x 75 x 60	0,439	1	IP20, class II, 3m black textile cable, incl. canopy	Aluminium frame, plastic blades

2018-1



Bell+

/ design by Thomas Holst Madsen

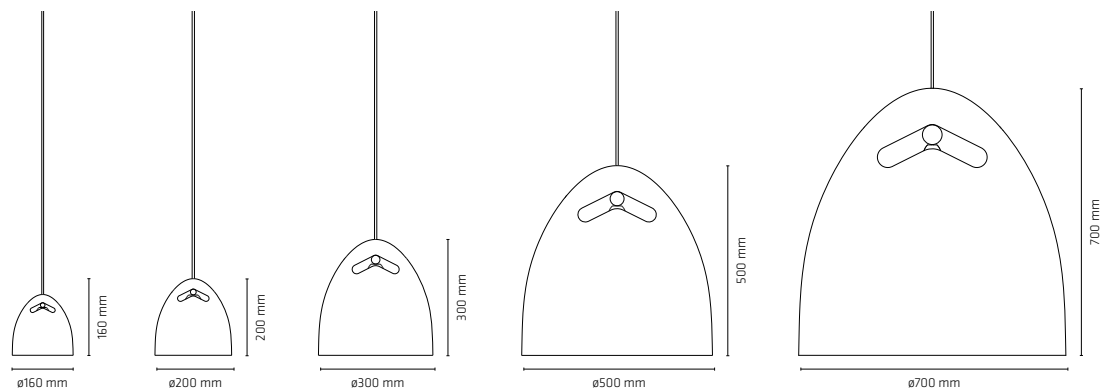

Product	Type	Colour	Item no.	EAN number	Watt-Socket-Voltage	Light source
Bell+ 16 P1	pendant	Oak-white	D10P116702	57 09349 026553	40W - G9 - 240V	Excl.
Bell+ 16 P1	pendant	Oak-black	D10P116703	57 09349 026560	40W - G9 - 240V	Excl.
Bell+ 20 P1	pendant	Oak-white	D10P120702	57 09349 025105	60W - E27 - 240V	Excl.
Bell+ 20 P1	pendant	Oak-black	D10P120703	57 09349 025112	60W - E27 - 240V	Excl.
Bell+ 30 P1	pendant	Oak-white	D10P130702	57 09349 025136	100W - E27 - 240V	Excl.
Bell+ 30 P1	pendant	Oak-black	D10P130703	57 09349 025143	100W - E27 - 240V	Excl.
Bell+ 50 P1	pendant	Oak-white	D10P150702	57 09349 025167	100W - E27 - 240V	Excl.
Bell+ 50 P1	pendant	Oak-black	D10P150703	57 09349 025174	100W - E27 - 240V	Excl.
Bell+ 70 P1	pendant	Oak-white	D10P170702	57 09349 025181	100W - E27 - 240V	Excl.
Bell+ 70 P1	pendant	Oak-black	D10P170703	57 09349 025198	100W - E27 - 240V	Excl.

BELL+ Universe optional colours - online at www.daroe.dk

Shipping information	Net. Weight KGS	Gross weight KGS	Box dimension cm	CBM	PCS./Master	Installation	Material
Product	(product)	(incl. Packaging)					
Bell+ 16 P1	0,592	0,766	18 x 18 x 19	0,008	1/2	IP20, class II, 3m textile cable, incl. canopy	Aluminium shade / oak wood bar
Bell+ 20 P1	0,860	1,000	24 x 25 x 24	0,019	1/2	IP20, class II, 3m textile cable, incl. canopy	Aluminium shade / oak wood bar
Bell+ 30 P1	1,160	1,880	34 x 34 x 34	0,051	1/2	IP20, class II, 3m textile cable, incl. canopy	Aluminium shade / oak wood bar
Bell+ 50 P1	3,100	4,760	55 x 55 x 55	0,216	1/2	IP20, class II, 3m textile cable, incl. canopy	Aluminium shade / oak wood bar
Bell+ 70 P1	5,500	11,860	76 x 76 x 76	0,571	1	IP20, class II, 3m textile cable, incl. canopy	Aluminium shade / oak wood bar

2018-1

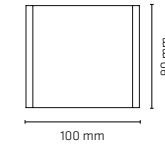
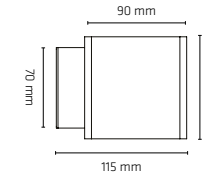
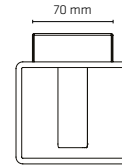

Costa

/ design by Thomas Darø

Product	Type	Colour	Item no.	EAN number	Watt-Socket-Voltage	Light source
Costa 10 W1	wall lamp	Matt white	D88V102	57 09349 024801	33W - G9 - 240V	Excl.
Costa 10 W1	wall lamp	Matt black	D88V103	57 09349 024818	33W - G9 - 240V	Excl.

Shipping information	Net. Weight KGS	Gross weight KGS	Box dimension cm	CBM	PCS./Master	Installation	Material
Product	(product)	(incl. Packaging)					
Costa 10 W1	0,660	0,856	17 x 16 x 15	0,005	1/3/12	IP20, class II, 2m transparent cable, with in-line switch and euro-plug	Aluminium shade / steel backplate

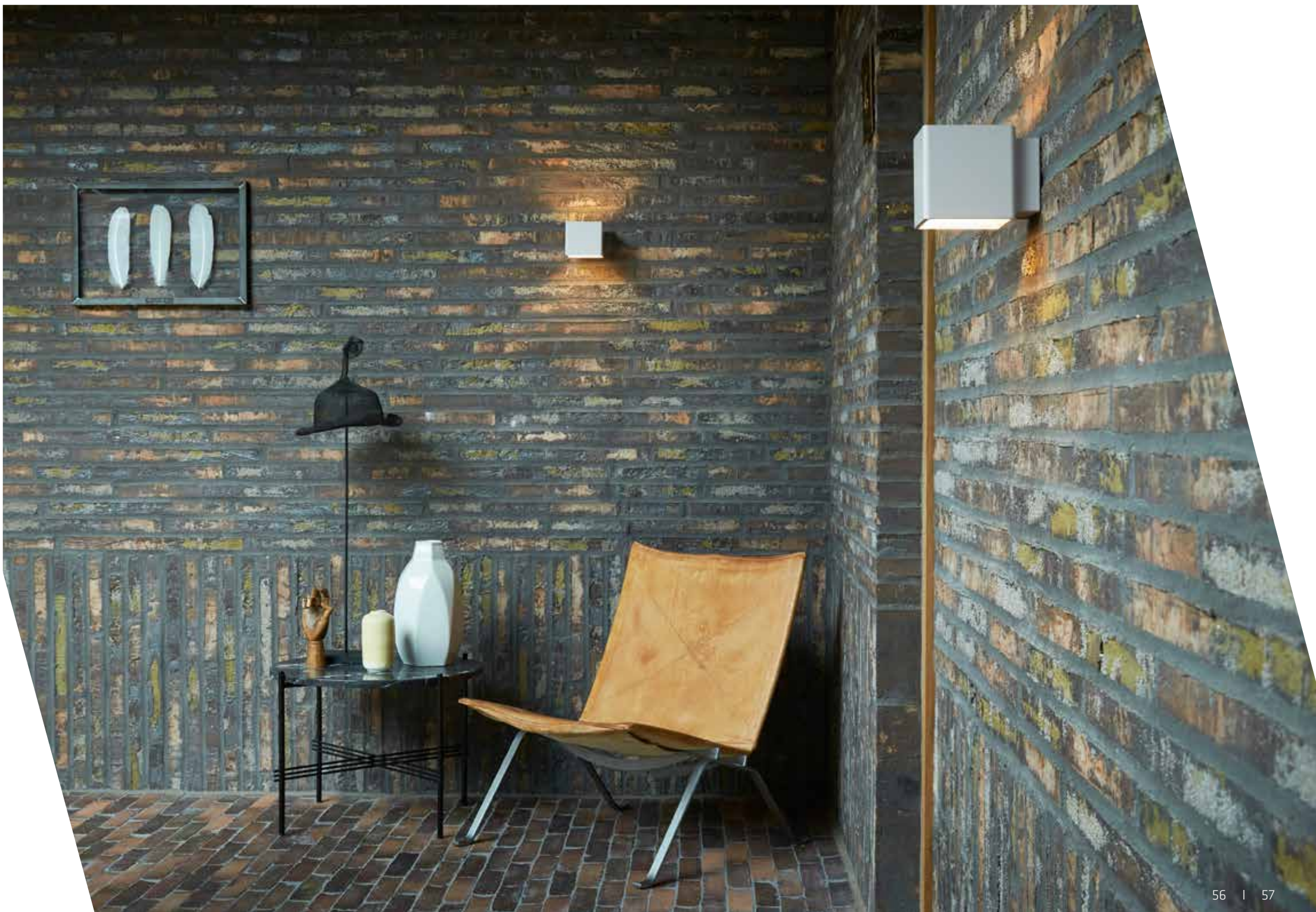

2018-1

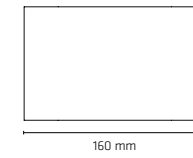
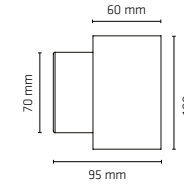
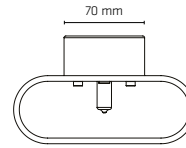

Fiora

/ design by Thomas Darø

Product	Type	Colour	Item no.	EAN number	Watt-Socket-Voltage	Light source
Fiora 16 W1	wall lamp	Matt white	R103V2	57 09349 024863	33W - G9 - 240V	Excl.
Fiora 16 W1	wall lamp	Matt black	R103V3	57 09349 024870	33W - G9 - 240V	Excl.

Shipping information	Net. Weight KGS (product)	Gross weight KGS (incl. Packaging)	Box dimension cm	CBM	PCS./Master	Installation	Material
Fiora 16 W1	0,720	0,880	21 x 12 x 14	0,005	1/3/12	IP20, class II, 2m transparent cable, with in-line switch and euro-plug	Aluminium shade / steel backplate

2018-1

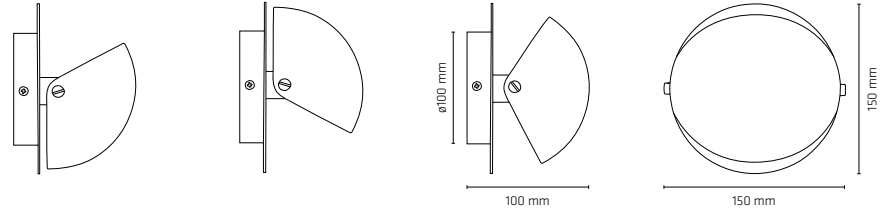

Gisario

/ design by Kjeld Darrø

Product	Type	Colour	Item no.	EAN number	Watt-Socket-Voltage	Light source
Gisario 15 W1	wall lamp	Satin chrome	R681V4	57 09349 023897	48W - G9 - 240V	Excl.
Gisario 15 W1	wall lamp	White	R681V12	57 09349 020681	48W - G9 - 240V	Excl.
Gisario 15 W1	wall lamp	Black	R681V13	57 09349 021244	48W - G9 - 240V	Excl.

Shipping information	Net. Weight KGS (product)	Gross weight KGS (incl. Packaging)	Box dimension cm	CBM	PCS./Master	Installation	Material
Gisario 15 W1	0,760	0,928	19 x 13 x 19	0,006	1/3/12	IP20, class II, 2m transparent cable, with in-line switch and euro-plug	Steel

2018-1



Trion

/ design by Thomas Darø

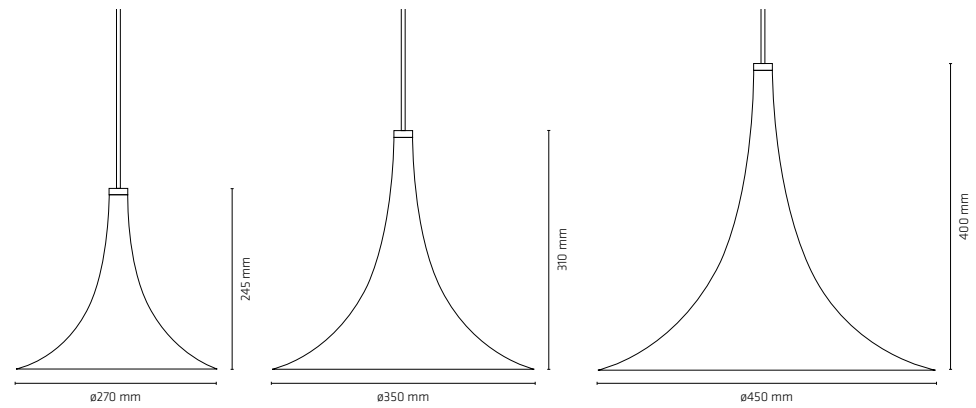

Product	Type	Colour	Item no.	EAN number	Watt-Socket-Voltage	Light source
Trion 27 P1	pendant	Brass-white	D120P2712	57 09349 024184	60W - E27 - 240V	Excl.
Trion 27 P1	pendant	Brass-black	D120P2713	57 09349 024191	60W - E27 - 240V	Excl.
Trion 35 P1	pendant	Brass-white	D120P3512	57 09349 024221	100W - E27 - 240V	Excl.
Trion 35 P1	pendant	Brass-black	D120P3513	57 09349 024238	100W - E27 - 240V	Excl.
Trion 45 P1	pendant	Brass-white	D120P4512	57 09349 024269	100W - E27 - 240V	Excl.
Trion 45 P1	pendant	Brass-black	D120P4513	57 09349 024306	100W - E27 - 240V	Excl.

TRION Universe optional colours - online at www.daroe.dk

Shipping information	Net. weight KGS	Gross weight KGS	Box dimension cm	CBM	PCS/Master	Installation	Material
Product	(product)	(incl. packaging)					
Trion 27 P1	0,660	1,040	29 x 29 x 28	0,031	1/2	IP20, class II, 3m textile cable, incl. canopy	Aluminium shade
Trion 35 P1	0,780	1,380	38 x 38 x 35	0,066	1/2	IP20, class II, 3m textile cable, incl. canopy	Aluminium shade
Trion 45 P1	1,070	2,300	47 x 47 x 44,5	0,128	1/2	IP20, class II, 3m textile cable, incl. canopy	Aluminium shade



2018-1



Paso Tri

/ design by Thomas Darø

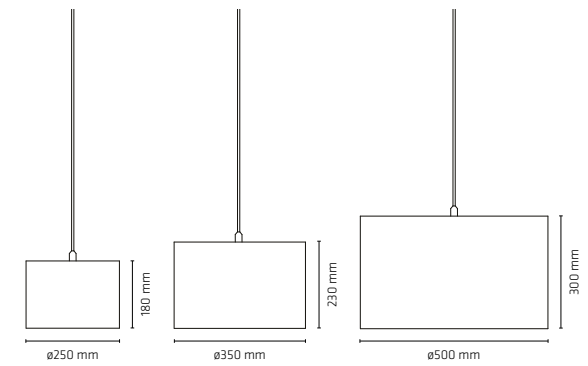
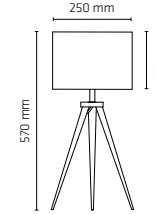
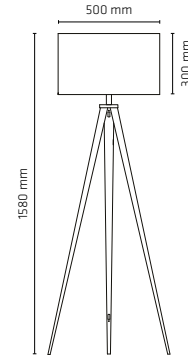

Product	Type	Colour	Item no.	EAN number	Watt-Socket-Voltage	Light source
Paso Tri 25 P1	pendant	Black-black cord	R110P2513	57 09349 024603	60W - E27 - 240V	Excl.
Paso Tri 35 P1	pendant	Black-black cord	R110P3513	57 09349 021893	60W - E27 - 240V	Excl.
Paso Tri 50 P1	pendant	Black-black cord	R110P5013	57 09349 021916	60W - E27 - 240V	Excl.
Paso Tri 25 T1	table lamp	Black-black	R111T2533	57 09349 024696	60W - E27 - 240V	Excl.
Paso Tri 50 F1	floor lamp	Black-black	R111F5033	57 09349 024689	100W - E27 - 240V	Excl.

PASO TRI Universe optional colours - online at www.daroe.dk

Shipping information	Net. Weight KGS	Gross weight KGS	Box dimension cm	CBM	PCS./Master	Installation	Material
Product	(product)	(incl. Packaging)					
Paso Tri 25 P1	0,730	1,030	28 x 28 x 19	0,019	1	IP20, class II, 3m black textile cable, incl. canopy	Steel top / textile shade / acrylic
Paso Tri 35 P1	1,010	1,540	37 x 37 x 19	0,034	1	IP20, class II, 3m black textile cable, incl. canopy	Steel top / textile shade / acrylic
Paso Tri 50 P1	1,670	2,390	53 x 53 x 19	0,069	1	IP20, class II, 3m black textile cable, incl. canopy	Steel top / textile shade / acrylic
Paso Tri 25 T1	0,940	2,300	32 x 31 x 19	0,025	1/4	IP20, class II, 2m black textile cable, with in-line switch and euro-plug	Steel base / textile shade
Paso Tri 50 F1	4,000	7,200	55 x 129 x 15	0,138	1	IP20, class II, 2m black textile cable, with foot-switch and euro-plug	Steel base / textile shade

2018-1



Paso Wood

/ design by Says Who

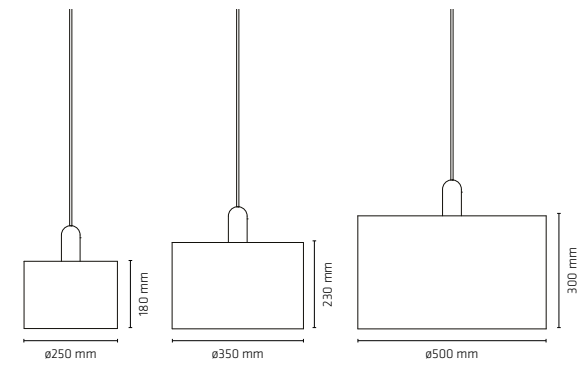
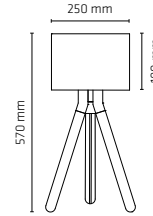
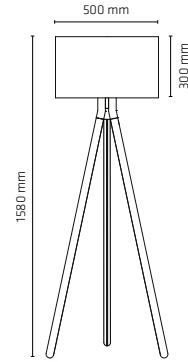

Product	Type	Colour	Item no.	EAN number	Watt-Socket-Voltage	Light source
Paso Wood 25 P1	pendant	Oak/black-black cord	R112P257033	57 09349 025051	60W - E27 - 240V	Excl.
Paso Wood 35 P1	pendant	Oak/black-black cord	R112P307033	57 09349 025068	60W - E27 - 240V	Excl.
Paso Wood 50 P1	pendant	Oak/black-black cord	R112P507033	57 09349 025075	60W - E27 - 240V	Excl.
Paso Wood 25 T1	table lamp	Oak-black/black	R112T25703	57 09349 025037	60W - E27 - 240V	Excl.
Paso Wood 50 F1	floor lamp	Oak-black/black	R112F50703	57 09349 025044	100W - E27 - 240V	Excl.

PASO WOOD Universe optional colours - online at www.daroe.dk

Shipping information	Net. Weight KGS	Gross weight KGS	Box dimension cm	CBM	PCS./Master	Installation	Material
Product	(product)	(incl. Packaging)					
Paso Wood 25 P1	0,830	1,130	28 x 28 x 19	0,019	1	IP20, class II, 3m black textile cable, incl. canopy	Oak wood / steel / textile / acrylic
Paso Wood 35 P1	1,070	1,500	37 x 37 x 19	0,034	1	IP20, class II, 3m black textile cable, incl. canopy	Oak wood / steel / textile / acrylic
Paso Wood 50 P1	1,770	2,050	53 x 53 x 19	0,069	1	IP20, class II, 3m black textile cable, incl. canopy	Oak wood / steel / textile / acrylic
Paso Wood 25 T1	1,400	2,300	32 x 31 x 19	0,025	1/4	IP20, class II, 2m black textile cable, w/in-line switch and euro-plug	Oak wood / steel / textile
Paso Wood 50 F1	4,200	8,000	55 x 129 x 15	0,138	1	IP20, class II, 2m black textile cable, w/foot-switch and euro-plug	Oak wood / steel / textile

DARØ®

Darø a/s | Ribevej 8 | 8940 Randers SV | Denmark | +458643 5066 | mail@daroe.dk | www.daroe.dk